

THERMOCOUPLE - Compact

STANDARD TYPE

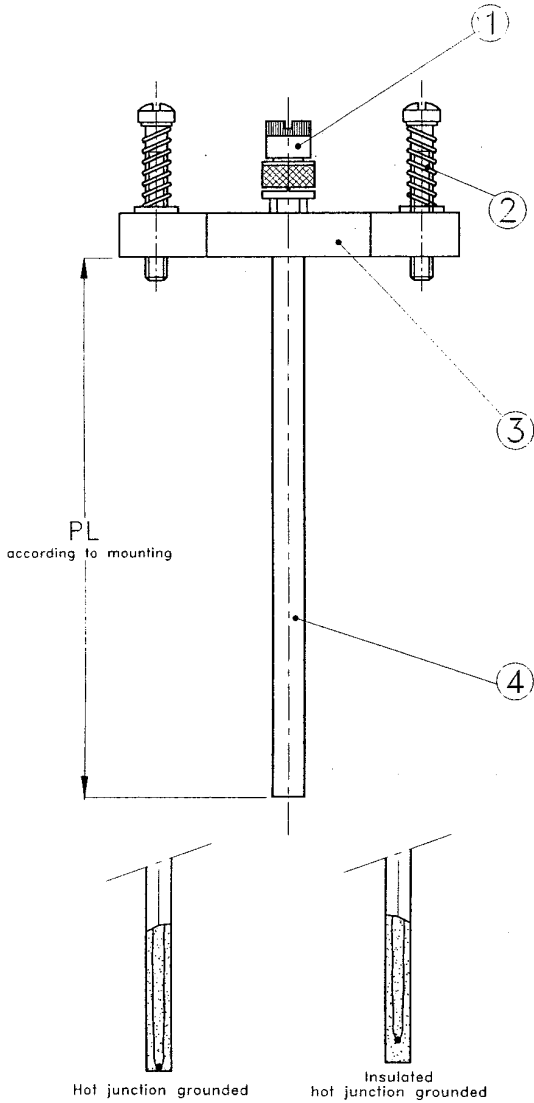

DIN TYPE

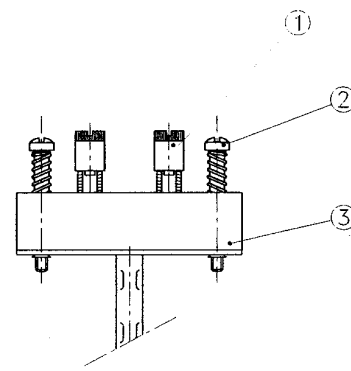

CONNECTING BLOCK THERMOCOUPLE
DIN TYPE SINGLE - 3 WIRES

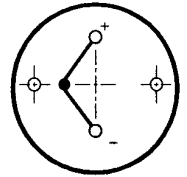

CONNECTING BLOCK THERMOCOUPLE
DIN TYPE DUPLEX - 4 WIRES

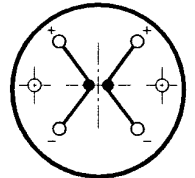

STANDARD

CONNECTING BLOCK THERMOCOUPLE
SINGLE TYPE - 2 WIRES

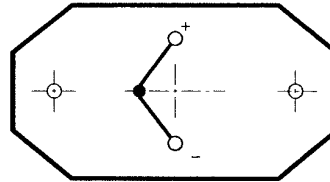

CONNECTING BLOCK THERMOCOUPLE
DUPLEX TYPE - 4 WIRES

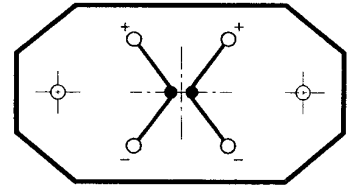

TRANSMITTER (according to notice)

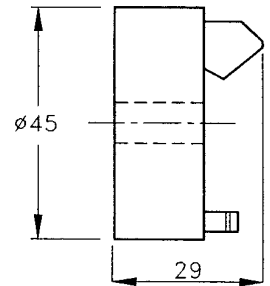
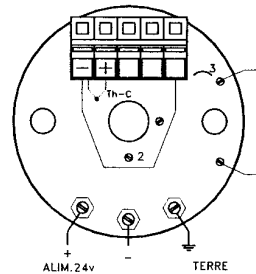

Technical description

- ① Connecting Nickel brass
- ② Screws (option spring system)
- ③ Refractory terminal blocks
- ④ Protecting magnesium

DESIGNATION SYMBOL

Thermocouple	SINGLE	S					
	DUPLEX	D					
Type	T - J - K - N - S	K					
Diameter	Ø3 - Ø4,5 - Ø6 - Ø8	6					
Precision	classe B	R1					
	classe A	R2					
	Thermowell 304L . 321 . 316L . 320 Inconel . Incoloy	321					
Connecting block	standard	S					
	DIN	D					
	Transmitter	T					
Length (under connecting block)		PL					

EXAMPLE

